



50Ω TERMINATED 3 GHz SMA FAILSAFE D.P.3.T. SWITCH

OPTIONS :/SUPP.DIODES

R F CHARACTERISTICS

FREQUENCY RANGE : 0 - 3 GHz
IMPEDANCE : 50 Ohms

FREQUENCY (GHz)	0 - 3
V.S.W.R <=	1.20
INSERT. LOSS <=	0.20 dB
ISOLATION >=	80 dB
AVER. POWER (*)	240 W

ELECTRICAL CHARACTERISTICS

ACTUATOR : FAILSAFE
NOMINAL CURRENT AT 25° C (±10%) : 204 mA
ACTUATOR VOLTAGE (Vcc) : 28V (24 to 30V)
TERMINALS : solder pins (250° C max./30 sec.)

MECHANICAL CHARACTERISTICS

CONNECTORS : SMA female per MIL C 39012
LIFE : 2.000.000 cycles
SWITCHING TIME (nominal voltage;25° C) : < 10 ms
CONSTRUCTION : splashproof
WEIGHT : < 100 g

ENVIRONMENTAL CHARACTERISTICS

OPERATING TEMPERATURE RANGE (°C) : -40 , +85
STORAGE TEMPERATURE RANGE (°C) : -55 , +85

(* : average power at 25° C)

4112-9212 This information is given as an indication. In the continual goal to improve our products, we reserve the right to make any modifications judged necessary

DRAWING

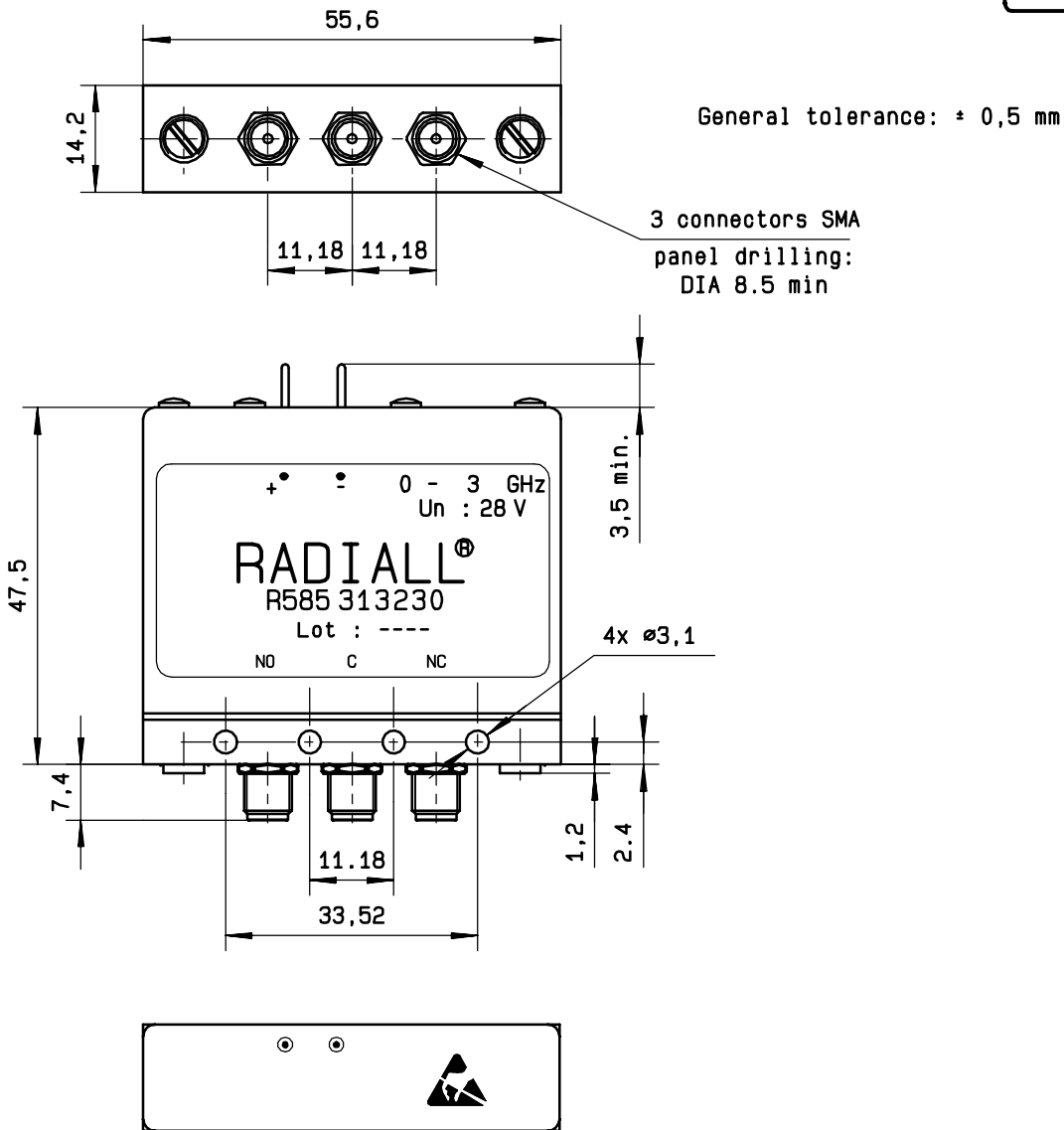

SCHEMATIC DIAGRAM

Voltage	RF continuity
De-energized	C \leftrightarrow NC / NO \leftrightarrow 50 Ω
Energized	C \leftrightarrow NO / NC \leftrightarrow 50 Ω

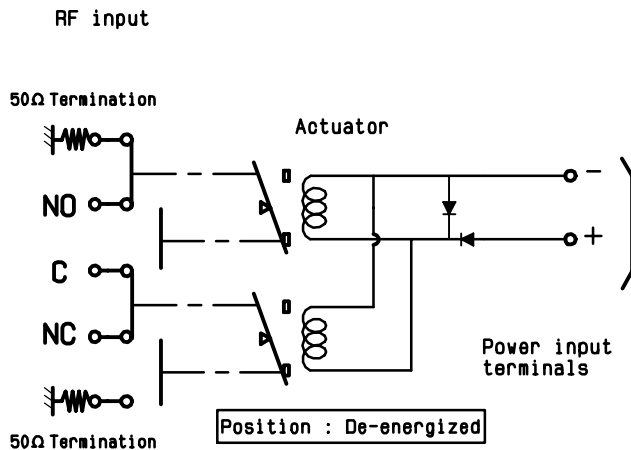

4113-9212 This information is given as an indication. In the continual goal to improve our products, we reserve the right to make any modifications judged necessary